



MANDRINI PORTAPINZA TIPO ER
ER COLLET CHUCK
MANDRINS A PINCES TYPE ER
SPANNZAGENFUTTER ER TYPE



DIN 69871 AD/B

DIN 6499

Bilanciato G.6,3 12.000 RPM

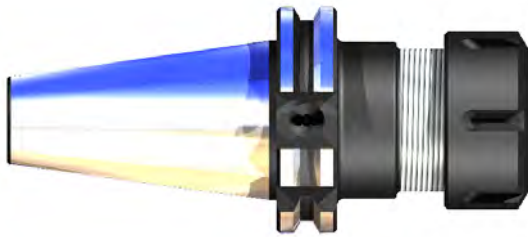

FIG. 1

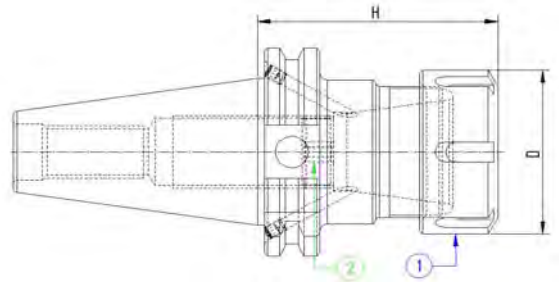
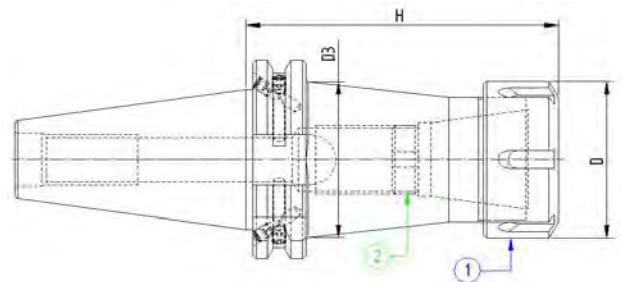

FIG. 2



Codice	ISO	Descrizione	H	D	D3	FIG.
140PP110	40	ISO40 DIN69871 P/P H.70 ER16	70	32	-	1
140PP113	40	ISO40 DIN69871 P/P H.70 ER20	70	35	-	1
140PP116	40	ISO40 DIN69871 P/P H.70 ER25	70	42	-	1
140PP120	40	ISO40 DIN69871 P/P H.70 ER32	70	50	-	1
140PP126	40	ISO40 DIN69871 P/P H.70 ER40	70	63	-	1
140PP210	40	ISO40 DIN69871 P/P H.100 ER16	100	32	-	2
140PP213	40	ISO40 DIN69871 P/P H.100 ER20	100	35	-	2
140PP216	40	ISO40 DIN69871 P/P H.100 ER25	100	42	-	2
140PP220	40	ISO40 DIN69871 P/P H.100 ER32	100	50	-	2
140PP226	40	ISO40 DIN69871 P/P H.100 ER40	100	63	50	2

----- Secondo fattibilità, fornibili su richiesta con cono ISO 30 -----

COMPONENTI - SPARE PARTS - PIECES DETACHEES - ERSATZTEILE

ER **GHIERA** Q.tà **GRANO INT.** Q.tà



16	916GHREQ	1	101001601	1
20	920GHREQ	1	101001601	1
25	925GHREQ	1	101815801	1
32	932GHREQ	1	102215901	1
40	940GHREQ	1	103015901	1



MANDRINI PORTAPINZA TIPO ER
ER COLLET CHUCK
MANDRINS A PINCES TYPE ER
SPANNZAGENFUTTER ER TYPE



DIN 69871 AD/B

DIN 6499

Bilanciato G.6,3 12.000 RPM

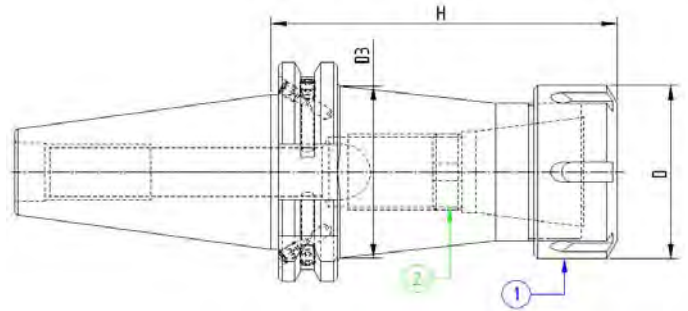
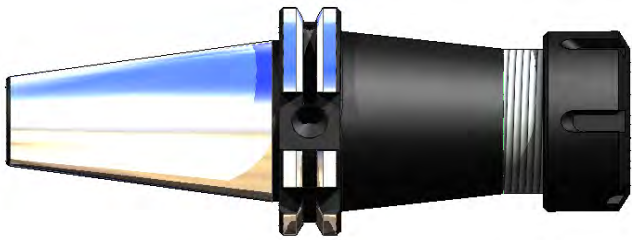

Codice	ISO	Descrizione	H	D	D3
140PP310	40	ISO40 DIN69871 P/P H.130 ER16	130	32	38
140PP313	40	ISO40 DIN69871 P/P H.130 ER20	130	35	40
140PP316	40	ISO40 DIN69871 P/P H.130 ER25	130	42	-
140PP320	40	ISO40 DIN69871 P/P H.130 ER32	130	50	-
140PP326	40	ISO40 DIN69871 P/P H.130 ER40	130	63	-
140PP410	40	ISO40 DIN69871 P/P H.160 ER16	160	32	-
140PP413	40	ISO40 DIN69871 P/P H.160 ER20	160	35	43
140PP416	40	ISO40 DIN69871 P/P H.160 ER25	160	42	-
140PP420	40	ISO40 DIN69871 P/P H.160 ER32	160	50	-
140PP426	40	ISO40 DIN69871 P/P H.160 ER40	160	63	50
140PP510	40	ISO40 DIN69871 P/P H.200 ER16	200	32	-
140PP513	40	ISO40 DIN69871 P/P H.200 ER20	200	35	45
140PP516	40	ISO40 DIN69871 P/P H.200 ER25	200	42	-
140PP520	40	ISO40 DIN69871 P/P H.200 ER32	200	50	-
140PP526	40	ISO40 DIN69871 P/P H.200 ER40	200	63	50

----- Secondo fattibilità, fornibili su richiesta con cono ISO 30 -----

COMPONENTI - SPARE PARTS - PIÈCES DETACHEES - ERSATZTEILE

ER GHIERA Q.tà GRANO INT. Q.tà



16	916GHREQ	1	101001601	1
20	920GHREQ	1	101001601	1
25	925GHREQ	1	101815801	1
32	932GHREQ	1	102215901	1
40	940GHREQ	1	103015901	1



MANDRINI PORTAPINZA TIPO ER
ER COLLET CHUCK
MANDRINS A PINCES TYPE ER
SPANNZAGENFUTTER ER TYPE



DIN 69871 AD/B

DIN 6499

Bilanciato G.6,3 12.000 RPM

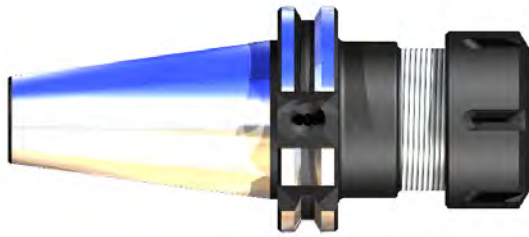

FIG. 1

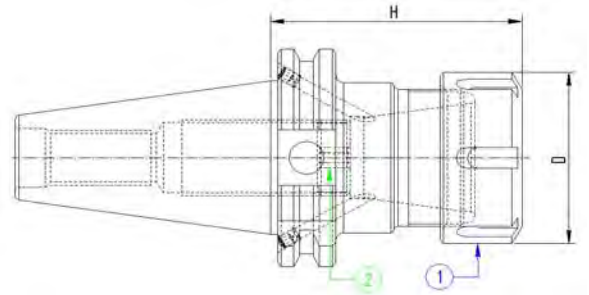
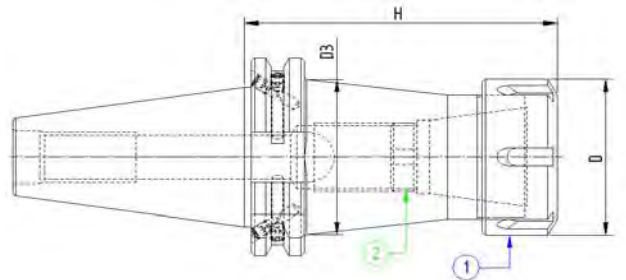

FIG. 2



Codice	ISO	Descrizione	H	D	D3	FIG.
150PP110	50	ISO50 DIN69871 P/P H80 ER16	80	32	-	1
150PP113	50	ISO50 DIN69871 P/P H80 ER20	80	35	-	1
150PP116	50	ISO50 DIN69871 P/P H80 ER25	80	42	-	1
150PP120	50	ISO50 DIN69871 P/P H80 ER32	80	50	-	1
150PP126	50	ISO50 DIN69871 P/P H80 ER40	80	63	-	1
150PP210	50	ISO50 DIN69871 P/P H100 ER16	100	32	-	2
150PP213	50	ISO50 DIN69871 P/P H100 ER20	100	35	-	2
150PP216	50	ISO50 DIN69871 P/P H100 ER25	100	42	-	2
150PP220	50	ISO50 DIN69871 P/P H100 ER32	100	50	-	2
150PP226	50	ISO50 DIN69871 P/P H100 ER40	100	63	-	2
150PP234	50	ISO50 DIN69871 P/P H100 ER50	100	-	-	2

----- Secondo fattibilità, fornibili su richiesta con cono ISO 30 -----

COMPONENTI - SPARE PARTS - PIECES DETACHEES - ERSATZTEILE

ER	GHIERA	Q.tà	GRANO INT.	Q.tà
----	--------	------	------------	------



16	916GHREQ	1	101001601	1
20	920GHREQ	1	101001601	1
25	925GHREQ	1	101815801	1
32	932GHREQ	1	102215901	1
40	940GHREQ	1	103015901	1
50	-	1	103015901	1



MANDRINI PORTAPINZA TIPO ER
ER COLLET CHUCK
MANDRINS A PINCES TYPE ER
SPANNZAGENFUTTER ER TYPE



DIN 69871 AD/B

DIN 6499

Bilanciato G.6,3 12.000 RPM

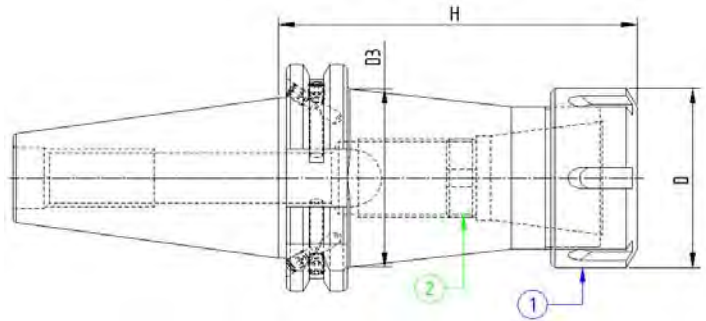
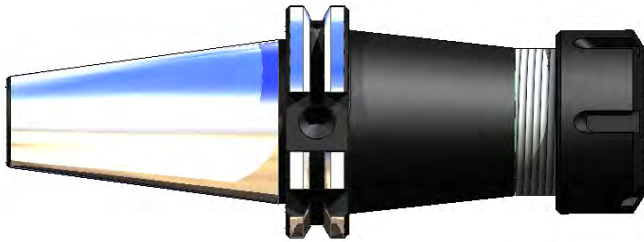

Codice	ISO	Descrizione	H	D	D3
150PP310	50	ISO50 DIN69871 P/P H130 ER16	130	32	37
150PP313	50	ISO50 DIN69871 P/P H130 ER20	130	35	40
150PP316	50	ISO50 DIN69871 P/P H130 ER25	130	42	47
150PP320	50	ISO50 DIN69871 P/P H130 ER32	130	50	-
150PP326	50	ISO50 DIN69871 P/P H130 ER40	130	63	-
150PP334	50	ISO50 DIN69871 P/P H130 ER50	130	-	-
150PP410	50	ISO50 DIN69871 P/P H160 ER16	160	32	-
150PP413	50	ISO50 DIN69871 P/P H160 ER20	160	35	43
150PP416	50	ISO50 DIN69871 P/P H160 ER25	160	42	-
150PP420	50	ISO50 DIN69871 P/P H160 ER32	160	50	-
150PP426	50	ISO50 DIN69871 P/P H160 ER40	160	63	-
150PP434	50	ISO50 DIN69871 P/P H160 ER50	160	-	-
150PP510	50	ISO50 DIN69871 P/P H200 ER16	200	32	-
150PP513	50	ISO50 DIN69871 P/P H200 ER20	200	35	45
150PP516	50	ISO50 DIN69871 P/P H200 ER25	200	42	-
150PP520	50	ISO50 DIN69871 P/P H200 ER32	200	50	-
150PP526	50	ISO50 DIN69871 P/P H200 ER40	200	63	-

----- Secondo fattibilità, fornibili su richiesta con cono ISO 30 -----

COMPONENTI - SPARE PARTS - PIECES DETACHEES - ERSATZTEILE

ER **GHIERA** Q.tà **GRANO INT.** Q.tà



16	916GHREQ	1	101001601	1
20	920GHREQ	1	101001601	1
25	925GHREQ	1	101815801	1
32	932GHREQ	1	102215901	1
40	940GHREQ	1	103015901	1
50	-	1	103015901	1



MANDRINI PORTAPINZA TIPO ER MINI
ER COLLET CHUCK MINI
MANDRINS A PINCES TYPE ER MINI
SPANNZAGENFUTTER ER TYPE MINI



DIN 69871 AD/B

DIN 6499

Bilanciato G.6,3 12.000 RPM

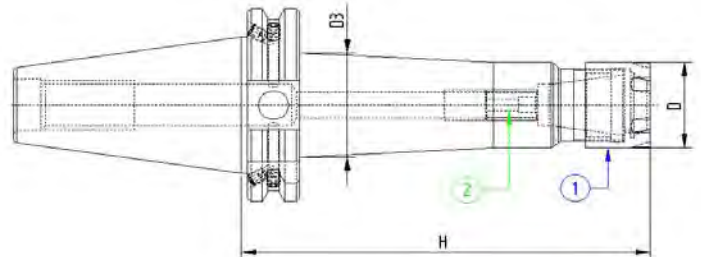
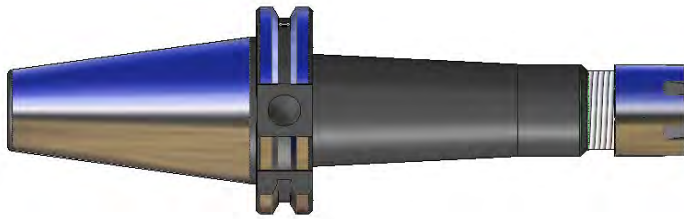

Codice	ISO	Descrizione	H	D3	D
140PM107	40	ISO40 DIN69871 P/P H70 ER11MINI	70	20	16
140PM110	40	ISO40 DIN69871 P/P H70 ER16MINI	70	26	22
140PM207	40	ISO40 DIN69871 P/P H100 ER11MINI	100	21	16
140PM210	40	ISO40 DIN69871 P/P H100 ER16MINI	100	27	22
140PM213	40	ISO40 DIN69871 P/P H100 ER20MINI	100	28	28
140PM216	40	ISO40 DIN69871 P/P H100 ER25MINI	100	35	35
140PM307	40	ISO40 DIN69871 P/P H130 ER11MINI	130	22	16
140PM310	40	ISO40 DIN69871 P/P H130 ER16MINI	130	27	22
140PM313	40	ISO40 DIN69871 P/P H130 ER20MINI	130	34	28
140PM316	40	ISO40 DIN69871 P/P H130 ER25MINI	130	35	35
140PM410	40	ISO40 DIN69871 P/P H160 ER16MINI	160	27	22
140PM413	40	ISO40 DIN69871 P/P H160 ER20MINI	160	35	28
140PM416	40	ISO40 DIN69871 P/P H160 ER25MINI	160	36	35
140PM510	40	ISO40 DIN69871 P/P H200 ER16MINI	200	32	22
140PM513	40	ISO40 DIN69871 P/P H200 ER20MINI	200	38	28
140PM516	40	ISO40 DIN69871 P/P H200 ER25MINI	200	45	35

----- Secondo fattibilità, fornibili su richiesta con cono ISO 30 -----

COMPONENTI - SPARE PARTS - PIECES DETACHEES - ERSATZTEILE

ER MINI **GHIERA** Q.tà **GRANO int.** Q.tà



11	911GHRMN	1	100601001	1
16	916GHRMN	1	101001601	1
20	920GHRMN	1	101001601	1
25	925GHRMN	1	101815801	1



MANDRINI PORTAPINZA TIPO ER MINI
ER COLLET CHUCK MINI
MANDRINS A PINCES TYPE ER MINI
SPANNZAGENFUTTER ER TYPE MINI



DIN 69871 AD/B

DIN 6499

Bilanciato G.6,3 12.000 RPM

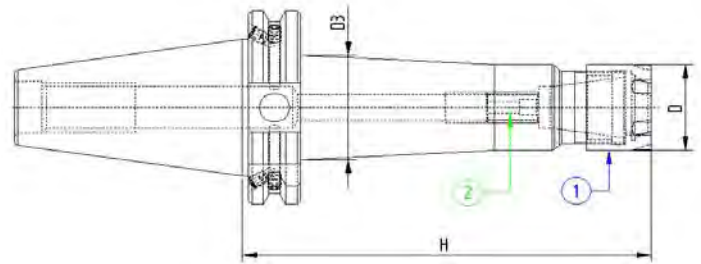
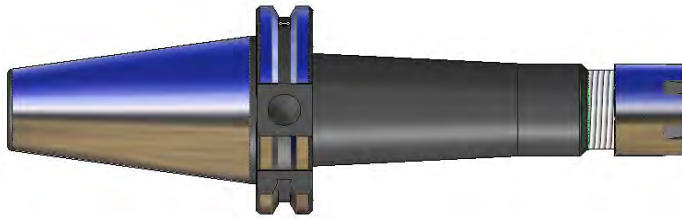

Codice	ISO	Descrizione	H	D3	D
150PM210	50	ISO50 DIN69871 P/P H100 ER16MINI	100	28	22
150PM213	50	ISO50 DIN69871 P/P H100 ER20MINI	100	31	28
150PM216	50	ISO50 DIN69871 P/P H100 ER25MINI	100	35	35
150PM310	50	ISO50 DIN69871 P/P H130 ER16MINI	130	27	22
150PM313	50	ISO50 DIN69871 P/P H130 ER20MINI	130	33	28
150PM316	50	ISO50 DIN69871 P/P H130 ER25MINI	130	40	35
150PM405	50	ISO50 DIN69871 P/P H160 ER08MINI	160	20	12
150PM407	50	ISO50 DIN69871 P/P H160 ER11MINI	160	23	16
150PM410	50	ISO50 DIN69871 P/P H160 ER16MINI	160	30	22
150PM413	50	ISO50 DIN69871 P/P H160 ER20MINI	160	35	28
150PM416	50	ISO50 DIN69871 P/P H160 ER25MINI	160	42	35
150PM510	50	ISO50 DIN69871 P/P H200 ER16MINI	200	30	22
150PM513	50	ISO50 DIN69871 P/P H200 ER20MINI	200	36	28
150PM516	50	ISO50 DIN69871 P/P H200 ER25MINI	200	44	35

----- Secondo fattibilità, fornibili su richiesta con cono ISO 30 -----

COMPONENTI - SPARE PARTS - PIECES DETACHEES - ERSATZTEILE

ER MINI **GHIERA** Q.tà **GRANO int.** Q.tà



8	908GHRMN	1	-	-
11	911GHRMN	1	100601001	1
16	916GHRMN	1	101001601	1
20	920GHRMN	1	101001601	1
25	925GHRMN	1	101815801	1